

Canon EF LENS

EF70-300mm f/4-5.6L IS USM



IMAGE STABILIZER
ULTRASONIC

ENG
Instruction

Thank you for purchasing a Canon product.

Dedicated to EOS cameras, the Canon EF70-300mm f/4-5.6L IS USM lens is a high-performance telephoto zoom lens equipped with an Image Stabilizer.

- “IS” stands for Image Stabilizer.
- “USM” stands for Ultrasonic Motor.

Features

1. The Image Stabilizer gives the equivalent effect of a shutter speed four stops faster*. The lens also has a second image stabilizer mode that is optimized for following shots of moving subjects.
2. UD lens elements for excellent imaging performance.
3. A fluorine coating has been applied to the lens's front and rear lens elements which allows dust to be wiped from the outside of the lens more easily compared with previous lenses.
4. Ultrasonic motor (USM) for quick and quiet autofocusing.
5. Manual focusing is available after the subject comes into focus in autofocus mode (ONE SHOT AF).
6. The zoom ring can be fixed to keep the lens at the shortest point.
7. A truly round aperture hole results in a nicer background blur.
8. Tight seal structure ensures excellent dust-proof and drip-proof performance.

* Based on [1/focal length] second. Generally, it requires a shutter speed [1/focal length] second or faster to prevent camera shake.

Conventions used in this instruction



Warning to prevent lens or camera malfunction or damage.



Supplementary notes on using the lens and taking pictures.

Safety Precautions

Safety Precautions

- **Do not look at the sun or a bright light source through the lens or camera.** Doing so could result in loss of vision. Looking at the sun directly through the lens is especially hazardous.
- **Whether it is attached to the camera or not, do not leave the lens under the sun without the lens cap attached.** This is to prevent the lens from concentrating the sun's rays, which could cause a fire.

Handling Cautions

- **If the lens is taken from a cold environment into a warm one, condensation may develop on the lens surface and internal parts.** To prevent condensation in this case, first put the lens into an airtight plastic bag before taking it from a cold to warm environment. Then take out the lens after it has warmed gradually. Do the same when taking the lens from a warm environment into a cold one.
- Do not leave the lens in excessive heat such as in a car in direct sunlight. **High temperatures can cause the lens to malfunction.**

This device complies with Part 15 of the FCC Rules. Operation is subject to the following two conditions: (1) This device may not cause harmful interference, and (2) this device must accept any interference received, including interference that may cause undesired operation.

Do not make any changes or modifications to the equipment unless otherwise specified in the instructions. If such changes or modifications should be made, you could be required to stop operation of the equipment.

This equipment has been tested and found to comply with the limits for a class B digital device, pursuant to part 15 of the FCC Rules. These limits are designed to provide reasonable protection against harmful interference in a residential installation. This equipment generates, uses and can radiate radio frequency energy and, if not installed and used in accordance with the instructions, may cause harmful interference to radio communications.

However, there is no guarantee that interference will not occur in a particular installation. If this equipment does cause harmful interference to radio or television reception, which can be determined by turning the equipment off and on, the user is encouraged to try to correct the interference by one or more of the following measures:

- Reorient or relocate the receiving antenna.
- Increase the separation between the equipment and receiver.
- Consult the dealer or an experienced radio/TV technician for help.

This Class B digital apparatus complies with Canadian ICES-003.

Nomenclature

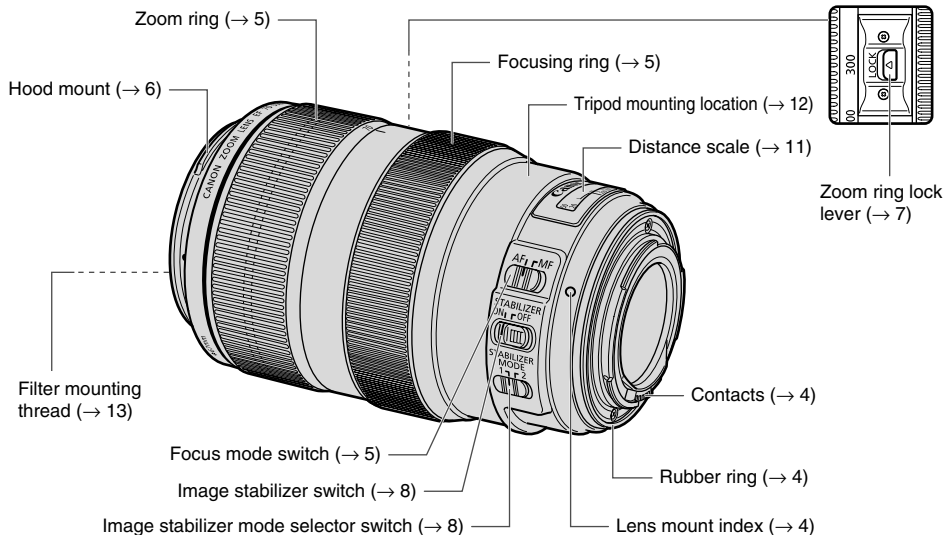



For detailed information, reference page numbers are provided in parentheses (→ **).

1. Mounting and Detaching the Lens

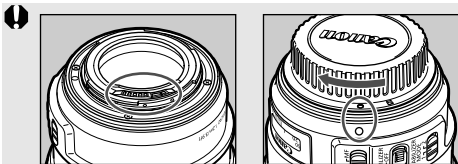
See your camera's instructions for details on mounting and detaching the lens.



- After detaching the lens, place the lens with the rear end up to prevent the lens surface and electrical contacts from getting scratched.
- If the contacts get soiled, scratched, or have fingerprints on them, corrosion or faulty connections can result. The camera and lens may not operate properly.
- If the contacts get soiled or have fingerprints on them, clean them with a soft cloth.
- If you remove the lens, cover it with the dust cap. To attach it properly, align the lens mount index and the  index of the dust cap as shown in the diagram, and turn clockwise. To remove it, reverse the order.

 The lens mount has a rubber ring for enhanced water- and dust-resistance. The rubber ring may cause slight abrasions around the camera's lens mount, but this will not cause any problems. If the rubber ring becomes worn, it is replaceable by a Canon Service Center at cost.

2. Setting the Focus Mode

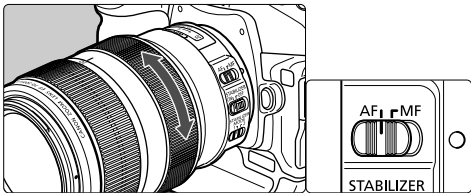

To shoot in autofocus (AF) mode, set the focus mode switch to AF.

To use only manual focusing (MF), set the focus mode switch to MF, and focus by turning the focusing ring. The focusing ring always works, regardless of the focus mode.



After autofocus in ONE SHOT AF mode, focus manually by pressing the shutter button halfway and turning the focusing ring. (Full-time manual focus)

3. Zooming

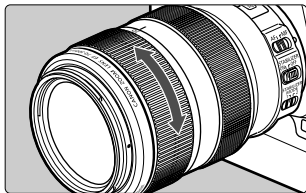

To zoom, turn the zoom ring.



Be sure to finish zooming before focusing. Zooming after focusing can affect the focus. Especially for shooting distances shorter than 3 m / 9.8 ft., zooming to another focal length will greatly change the focus.

4. Hood

The ET-73B hood can keep unwanted light out of the lens, and also protects the lens from rain, snow, and dust.

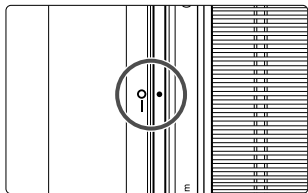
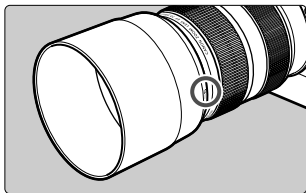
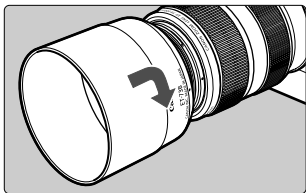

To attach the hood, align the hood's attachment position mark with the red dot on the front of the lens, then turn the hood as shown by the arrow until the lens' red dot is aligned with the hood's stop position mark.

The hood can be reverse-mounted on the lens for storage.



- Part of the picture may be blocked if the hood is not attached properly.
- When attaching or detaching the hood, grasp the base of the hood to turn it. To prevent deformation, do not grasp the rim of the hood to turn it.

5. Fixing the Zoom Ring

The zoom ring can be fixed to keep the lens at the shortest point. This function is convenient for carrying a camera on a strap because it prevents the lens from extending.

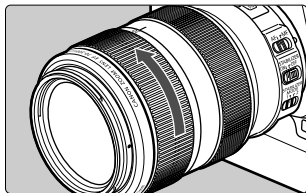
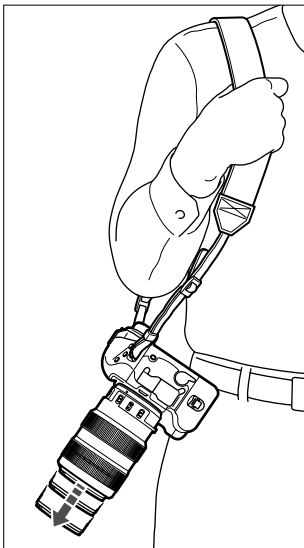

1 Turn the zoom ring to the widest position (70mm).

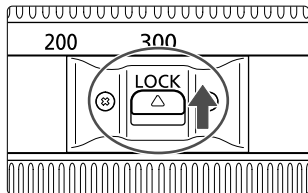

2 Slide the zoom ring lock lever in the direction indicated by the arrow.

- To release the zoom ring, slide the zoom ring lock lever in the direction opposite to the arrow.

 The zoom ring can only be locked at maximum wide angle.

6. Image Stabilizer Settings

You can use the image stabilizer in AF or MF mode.

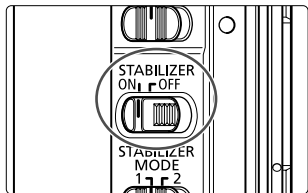

1 Set the STABILIZER switch to ON.

- If you are not going to use the image stabilizer function, set the switch to OFF.

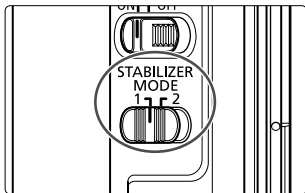

2 Select the stabilizer mode.

- **MODE 1:** Corrects vibrations in all directions. It is mainly effective for shooting still subjects.
- **MODE 2:** It compensates for vertical camera shake during following shots in a horizontal direction, and compensates for horizontal camera shake during following shots in a vertical direction.

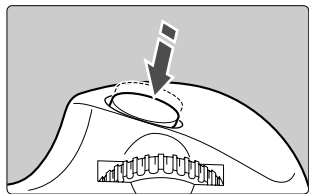

3 When you press the shutter button halfway, the Image Stabilizer will start operating.

- Make sure the image in the viewfinder is stable, then press the shutter button the rest of the way down to take the picture.

7. Tips on Using the Image Stabilizer

The image stabilizer in this lens is effective for hand-held shots under the following conditions.

● MODE 1



ON

OFF

- In semi-darkened areas such as indoors or outdoors at night.
- In locations where flash photography is prohibited, such as art museums and theater stages.
- In situations where your footing is uncertain.
- In situations where fast shutter settings cannot be used.

● MODE 2



ON

OFF

- When panning subjects in motion.

Tips on Using the Image Stabilizer



- The Image Stabilizer cannot compensate for a blurred shot caused by a subject that moved.
- Set the STABILIZER switch to OFF when you are taking pictures using the Bulb setting (long exposures). If the STABILIZER switch is set to ON, the image stabilizer function may introduce errors.
- The Image Stabilizer might not be fully effective in the following cases:
 - You shoot while riding on a bumpy road.
 - You move the camera dramatically for a panning shot in Mode 1.
 - You shoot using techniques other than following shots in Mode 2.
- The Image Stabilizer consumes more power than normal shooting, so fewer shots can be taken if you use the function.
- The image stabilizer operates for about two seconds even when your finger is off the shutter button. Do not remove the lens while the stabilizer is in operation. This will cause a malfunction.
- With the EOS-1V/HS, 3, ELAN 7E/ELAN 7/30/33, ELAN 7NE/ELAN 7N/30V/33V, ELAN II/ELAN IIE/50/50E, REBEL 2000/300, IX, and D30, the Image Stabilizer will not work during self-timer operation.



- Using a tripod also stabilizes the image. However, depending on the kind of tripod and shooting conditions, sometimes it may be better to turn off the Image Stabilizer function.
- Even with a monopod, the Image Stabilizer will be as effective as during hand-held shooting. However, depending on the shooting environment, the Image Stabilizer effect may be less effective.
- The image stabilizer function also operates when the lens is used with an Extension Tube EF12 II or EF25 II.
- Pictures may look distorted after being taken depending on the camera, but this doesn't affect shooting.
- If you set the camera's Custom Function to change the assigned button to operate the AF, the Image Stabilizer will operate when you press the newly assigned AF button.

8. Infinity Compensation Mark

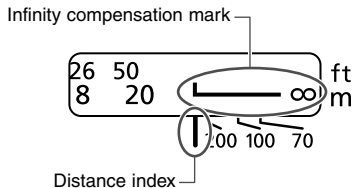

To compensate for shifting of the infinity focus point that results from changes in temperature. The infinity position at normal temperature is the point at which the vertical line of the L mark is aligned with the distance indicator on the distance scale.

 For accurate manual focusing of subjects at infinity, look through the viewfinder or look at the magnified image* on the LCD screen while rotating the focusing ring.

* For cameras with Live View shooting capability.

9. Infrared Index

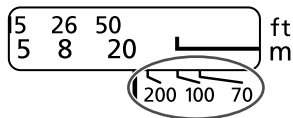

The infrared index corrects the focus setting when using monochrome infrared film. Focus on the subject manually, then adjust the distance setting by moving the focusing ring to the corresponding infrared index mark.

 Some EOS cameras cannot use infrared film. See the instructions for your EOS camera.

- 
- The infrared index position is based on a wavelength of 800 nm.
 - The compensation amount differs depending on the focal length. Use the indicated focal length as a guide when setting the compensation amount.
 - Be sure to observe the manufacturer's instructions when using infrared film.
 - Use a red filter when you take the picture.

10. Using the Tripod Mount (Sold separately)

Adjusting the Revolving Mount

This lens can be used with the C (W II) tripod mount ring, sold separately.

You can loosen the orientation lock-knob on the tripod mount to allow it to rotate as needed to fit a particular camera model for switching between vertical and horizontal positions.

Detaching

Use the following procedures to remove and attach the tripod mount.

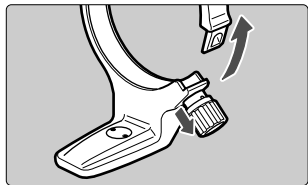

- 1 Turn the locking knob counterclockwise until it becomes loose (about 3 turns), and pull the knob in the direction of the arrow to release the collar.

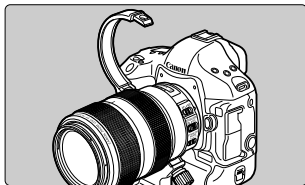

- 2 With the collar open, remove the tripod mount.

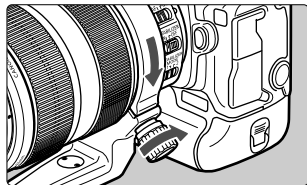

- 3 To install, while pulling the locking knob, bring the collar to the original position, and tighten the locking knob securely.

 Depending on the EOS camera model, if a battery pack or vertical grip is attached, the tripod mount may bump into it. If that is the case, remove the battery pack/vertical grip or the tripod mount.

 The tripod collar can be attached to or detached from the lens while the lens is attached to the camera.

11. Filters (Sold separately)

You can attach filters to the filter mounting thread on the front of the lens.



- If you need a polarizing filter, use the Canon Circular Polarizing Filter (67mm).
- To adjust the polarizing filter, first remove the lens hood.

12. Extension Tubes (Sold separately)

(Sold separately)

You can attach Extension Tube EF12 II or EF25 II for magnified shots. The shooting distance and magnification are shown below.

		Camera-to-Subject Distance (mm)		Magnification	
		Near	Far	Near	Far
EF12 II	70mm	469	627	0.25×	0.17×
	300mm	1011	7584	0.29×	0.04×
EF25 II	70mm	357	410	0.47×	0.38×
	300mm	887	3842	0.38×	0.09×



Manual focusing is recommended for accurate focusing.

Specifications

Focal Length/Aperture	70-300 mm f/4-5.6
Lens Construction	14 groups, 19 elements
Minimum Aperture	f/32-45
Angle of View	Diagonal: 34° - 8° 15' Vertical: 19° 30' - 4° 35' Horizontal: 29° - 6° 50'
Min. Focusing Distance	1.2 m / 3.9 ft.
Max. Magnification	0.21× (at 300 mm)
Field of View	364 × 545 - 113 × 169 mm / 14.3 × 21.5 - 4.4 × 6.7 in. (at 1.2 m)
Filter Diameter	67 mm / 2.6 in.
Max. Diameter and Length	89 × 143 mm / 3.5 × 5.6 in.
Weight	approx. 1050 g / 37 oz.
Hood	ET-73B
Lens Cap	E-67U
Case	LP1424
Tripod Collar	Ring-type tripod mounting socket C (W II) (Sold separately)

- The lens length is measured from the mount surface to the front end of the lens. Add 21.5 mm when including the lens cap and dust cap.
- The size and weight listed are for the lens only, except as indicated.
- The EF1.4X III/EF1.4X II/EF2X III/EF2X II extenders cannot be used with this lens. There are no compatible close-up lenses.
- Aperture settings are specified on the camera. The camera automatically compensates for variations in the aperture setting when the camera is zoomed in or out.
- All data listed is measured according to Canon standards.
- Product specifications and appearance are subject to change without notice.

Canon